

SERIES 3000/4000

CASEMENT AND AWNING WINDOWS



Craftsmanship. Style. Performance.

Strassburger
SINCE 1949
WINDOWS AND DOORS



Howling Wind, Beating Rain, Bone-Chilling Cold or Scorching Heat...

Strassburger casement and awning windows give you the best protection and the greatest comfort a window can provide

The remarkable performance of Strassburger windows is the result of attention to the smallest of details in the quest for premium product quality.

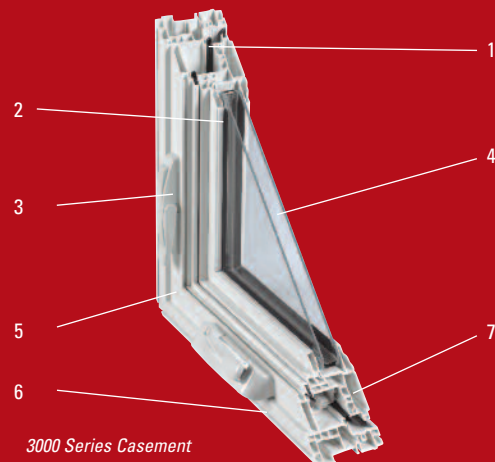

3000 Series Casement



4000 Series Casement

- 1 Triple weather-stripping provides remarkable air tightness, reducing heating and air conditioning costs
- 2 Interior glazing bead design allows the window to withstand winds of over 350 km/h (220 mph)
- 3 With a single handle, our stainless steel multi-point locking bar is activated
- 4 Accommodates virtually all types of glazing
- 5 Fusion welded seams create a 100% water and airtight surface and increase the structural integrity of frames and sashes
- 6 Interior and exterior grooves allow for brickmoulds, nailing flanges, returns and jamb extensions
- 7 Strassburger windows have the highest number of internal chambers

Performance - Test Results

	Air	Water	Wind	Forced Entry
Casement	A3	B7	C5	F2
Awning	A3	B7	C5	F2
Ind. Standard	A1	B1	C1	F1

Products tested to new NAFS standard (AAMA/WDMA/CSA101/I.S.S/A440-08)



Casement



Awning

3000 Series Casement / Awning

This 3 1/4" deep profile is versatile for new construction or replacement applications.

4000 Series Casement / Awning

At 4 9/16" deep, this profile comes complete with built-in drywall retainer. Ideal for new construction applications with deeper walls.

Casement windows open like doors. They are simple to operate, easy to clean and provide maximum airflow. Awning windows are very similar in function and performance. They open from the bottom out to provide the added benefit of preventing rainfall entry. Both window styles are ideal for the variable Canadian climate, are CSA-A440 compliant and meet EnergyStar® requirements.

- Designed to make life easier, a casement sash opens a full 90° for easy cleaning
- Window operation is smooth, consistent, and effortless
- Strassburger casement and awning windows have outstanding insulation and sound abatement qualities, as well as excellent thermal efficiency and increased strength
- 100% uPVC extrusions are designed to provide superior resistance to severe weather conditions
- Stainless steel multi-point locking system provides heavy-duty security
- Triple weather-stripping keeps the elements out
- Available in a range of glass types and thicknesses including single, double and triple glazing as well as decorative panels
- Designed to be aesthetically and structurally compatible with other Strassburger window and door styles
- Operating hardware is available in several colours and optional finishes
- Standard extrusion colour is solid white. See colour chart for exterior standard and custom colours



Performance

Easy to operate Truth Maxim hardware is designed to reduce air and water infiltration. Smooth functioning, durable mechanisms are concealed for a clean appearance.



Security

Elegant handles and multi-point latches secure the windows at three points to provide not only superior protection from the elements but also protection from tampering and vandalism.



It's All In The Details

Our attention to detail doesn't stop at the windows... it's the finishing touches that make a Strassburger window complete

Functionally artistic hardware

The stainless steel locking mechanism operates with a slim line locking lever that ensures your windows are water and airtight for optimum energy efficiency. Self-storing Encore folding handles swing out of the way to enhance the overall appearance of your windows. Available in 6 different finishes.



White

Brushed Nickel

Coppertone

Brushed Antique

Black

Oil-rubbed Bronze



White

Brushed Nickel

Coppertone

Brushed Antique

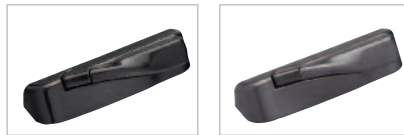

Black

Oil-rubbed Bronze



White

Black

Satin Nickel

Oil Rubbed



White

Black

Satin Nickel

Oil Rubbed

Brickmould and trim options

A wide variety of decorative brickmoulds, drywall returns, jamb extensions and trim options are available to finish the window. Most brickmoulds have tear-out systems to allow for siding. Available in standard white, these extrusions can be painted to match your chosen window frame colour.

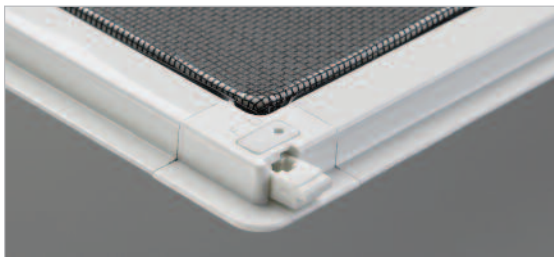
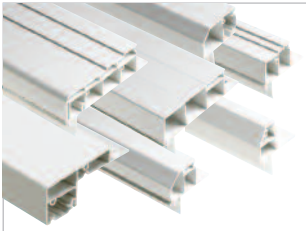

Strassburger screens are smooth, clean and tidy. Screen retention system is built into the corners, leaving a sleek profile.

Choose from a variety of patterns to create the window style that complements your architecture and your individual taste.

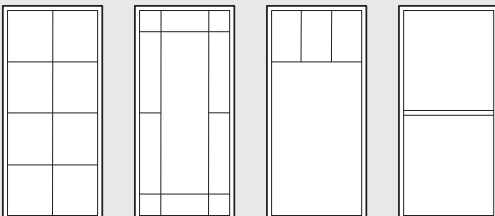

Colonial

Prairie

Ladder

2" Horizontal

Contemporary hardware options

Combine the handle and locking latch to both of our awning and casement products to create a unified contemporary look. The sleek, straight-line design is available in several fresh modern colours.



New technology turns glass into insulation

Strassburger windows are glazed with cutting edge technology from Cardinal Glass. Through research and engineering Cardinal glass adds new standards of comfort, energy savings and value to you home. Cardinal glass is specifically designed to let clear light stream into your home while rejecting the sun's heat and damaging UV rays that shorten the life of drapes and furniture. All Cardinal units come complete with the XL Edge spacer system which provides proven thermal and structural performance.

LoE-i89 turns double-pane windows into triple pane performers

- energy-saving roomside coated glass
- more light transmittance
- less reflectance

LoE-180 is the ideal glass for passive solar applications

- high solar gain
- blocks interior heat loss to outside
- dramatic comfort improvements

LoE²-272 delivers year round comfort

- reflects heat back into room on cold days
- promotes easier control and maintenance of interior air
- reflects harmful UV rays

LoE³-366 rejects the sun's heat without affecting the view

- provides premium insulation and comfort
- rejects 95% of sun's damaging UV rays
- highest levels of energy savings

Neat™ windows almost clean themselves

- ultra smooth glass treatment
- windows stay cleaner longer

Preserve™ factory applied protective film

- saves time, money and jobsite hassles
- simply peels off



Double and triple glazed windows deliver outstanding thermal performance. Low conductivity warm edge spacers keep the panes of glass apart.

Standard or custom. You pick the colour

You've chosen the right window to make your home just the way you want it, now it's time to pick that perfect colour. We offer 50 standard colours chosen specifically to complement any new home design or retro-fit. Custom colour matching is also available. All exterior colours come with a 15 year warranty. All exterior stain colours are warranted for 10 years.



These finishes are formulated to look better, last longer and are applied by our own specialists in a controlled, dust-free environment. We take care to use only water soluble paint so clean-up and disposal is efficient and doesn't affect the environment.

*Colour disclaimer: We cannot guarantee that the colours shown in the product images are exactly correct to the product. Please consult your Strassburger Windows and Doors dealer for a more accurate product and colour chip match.

The benefits of PVC, the appearance of wood

DoubleNature® provides a range of inspiring looks that add beauty and a feeling of cosy comfort to your project, whether it's large or small, doors or windows. DoubleNature® offers the organic and natural warmth of wood... without maintenance.

At once trendy and timeless, the natural wood finish of the DoubleNature® collection blends with other materials and textures to give your project its own unique look.

With a finish that is applied to the inside and outside of the vinyl frame system, DoubleNature® products provide the most realistic wood finish in the PVC industry. In conjunction with our variety of stained fibreglass doors it's the perfect combination of beauty and practicality, innovation and tradition.

DoubleNature® is a water-based, UV-resistant stain available in a range of natural colours inspired by some of the world's most noble wood species: cherry, golden pecan, mahogany, oak, redwood, and walnut.

DoubleNature® finish options



Grille and Simulated Divided Lites (SDL) designs complement your architectural style

Grilles placed within the airspace between the insulating glass create a sleek, traditional look that is easy to clean. We offer a wide selection of grille styles and colours* that will enhance the look of your windows and complement the design of the building. Surface mounted SDL bars create a unique and distinctive multi-pane effect known as simulated divided lites. Default grilles are pewter or an SDL grille.

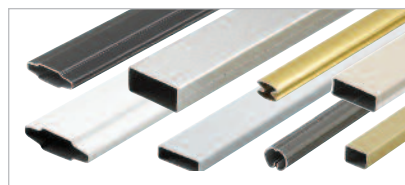

Grilles as located between the glass panes. Exact colour matches to grilles are not always possible.

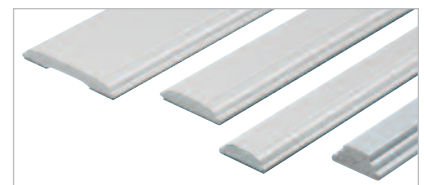

Simulated divided lites are placed on the surface of the glass and can be painted or stained.





The Energy Plus company since 1949

Proudly Canadian, we're dedicated to designing and building energy efficient products

Strassburger Energy Star® energy-efficient windows deliver year-round comfort and reduce, if not eliminate, condensation during colder weather. All Strassburger windows come with many glazing options to suit your needs and the region you live in.

To qualify for the Energy Star® mark, windows must meet strict technical requirements for thermal performance. They must qualify based on either their U-value (rate of heat transfer from a warm area to a cold area) or their Energy Rating (a scale that takes into account a product's U-value, potential solar gain and air tightness). To ensure the integrity of the Energy Star® mark, all product testing is done by accredited laboratories under standardized, quality-controlled conditions. Visit our website to review all the Energy Star® and NFRC ratings on all our products.

The best windows, backed by the best warranty

We're so confident in the windows we design and produce, we guarantee them for life

We promise to adhere to the highest standards of honesty and integrity in all our relationships with customers, suppliers, prospects and employees and at all times provide high-quality products and service.



See our complete line of windows and talk to one of our knowledgeable sales personnel at our head office show room.

For information on other outstanding fenestration products offered by Strassburger Windows and Doors visit: www.strassburger.net



Cardinal Glass Industries

